

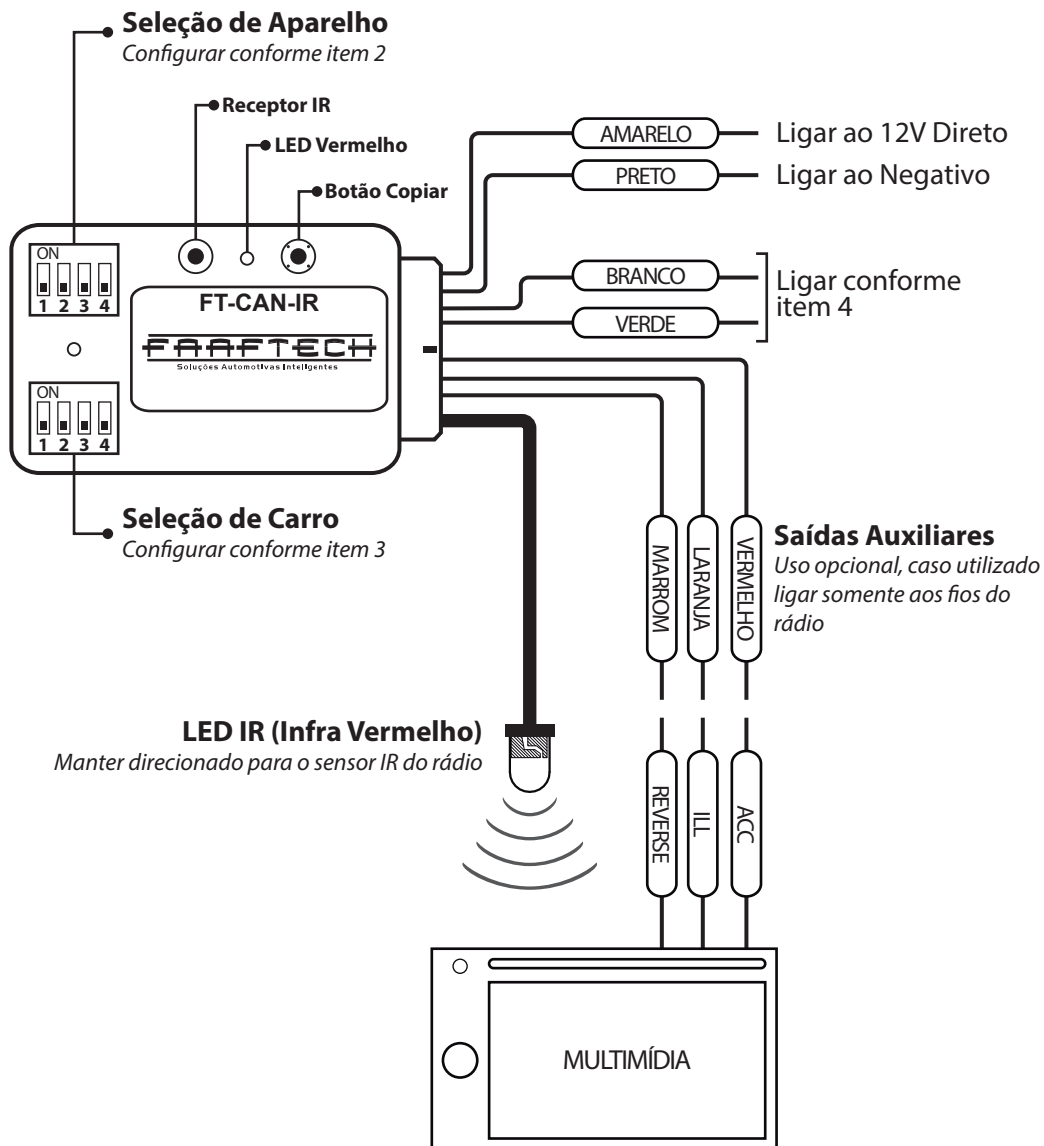



1. DIAGRAMA DE INSTALAÇÃO







Faça toda a instalação da interface com a ignição desligada e com o chicote da interface desconectado.



2. TABELA DE SELEÇÃO DE APARELHO

Configure os DIP Switches de seleção de aparelho de acordo com a tabela abaixo.

MARCA	CHAVEAMENTO
ALPINE	
CLARION	
JVC 1	
JVC 2	
KENWOOD	
LG	

MARCA	CHAVEAMENTO
PHILIPS 1	
PHILIPS 2	
PIONEER 1	
PIONEER 2	
SONY	
PROGRAMÁVEL	

Utilize a opção PROGRAMÁVEL para fazer a cópia do controle remoto quando instalado um aparelho não listado na tabela acima.

Quando utilizado o modo PROGRAMÁVEL é necessário fazer cópia dos comandos do controle remoto seguindo os passos abaixo:



- 1 - Pressione o botão MASTER da interface, o LED VERMELHO ficará aceso.
- 2 - Direcione o controle remoto do multimídia para o LED da interface, pressione e segure a tecla a ser copiada até que o LED VERMELHO fique piscando.
- 3 - Pressione a tecla correspondente no volante do carro, o LED VERMELHO da interface apagará e a tecla estará programada.
- 4 - Repita os passos de 1 a 3 para fazer a programação das demais teclas.

Utilize um aplicativo QR Code para visualizar o vídeo de programação ou acesse www.faafttech.com/config-ft-ir







3. TABELA DE SELEÇÃO DE CARRO

Configure os DIP Switches de seleção de carro de acordo com a tabela abaixo.

TABELA DE SELEÇÃO CARRO			
MARCA	CARROS	ANO	CHAVEAMENTO
Audi	A3 Sportback, TT	2008-2012	
BMW	Serie 1, Serie 3	2007-2011	
Citroen	Aircross, C3 Picasso, C4, C4 Picasso, C5	2006>	
Chrysler	300C	2005-2010	
	Town and Country	2008-2015	
Chevrolet	Camaro, Captiva, Cobalt, Cruze, Ônix, Prisma Sonic, Spin, Tracker	2006>	
Dodge	RAM 2500	2006-2010	
	RAM 2500	2011-2013	
	Journey	2008-2011	
Fiat	Bravo, Grand Siena, Linea, Palio Sporting, Stilo Punto	2007>	
	500	2007-2015	
Honda	Civic, CRV	2012>	
Hyundai	Azera	2012>	
Jeep	Compass	2012-2015	
	Cherokee	2006-2010	
	Cherokee, Grand Cherokee	2011-2013	
Mercedes	Classe CLC, Classe SLK	2006-2010	
	Classe C	2000-2007	
Peugeot	307, 308, 3008, 407, 408	2007>	
Porsche	Cayenne	2005-2010	



Continua próxima página

Renault	Mégane	2006-2010	
	Fluence	2011>	
Volkswagen	Gol, Voyage	2013>	
	Crossfox, Fox, Saveiro, Spacefox	2014>	ou 
	Amarok, Jetta, Passat, Tiguan	2006>	

4. CONEXÃO NO CARRO

Faça a ligação dos fios VERDE e BRANCO da interface seguindo o conector indicado na tabela abaixo.

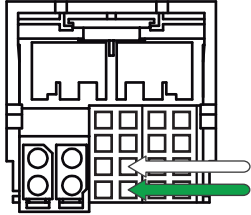
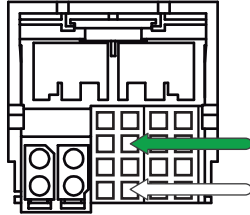
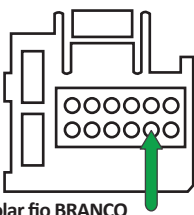
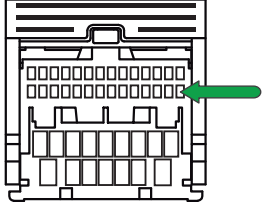
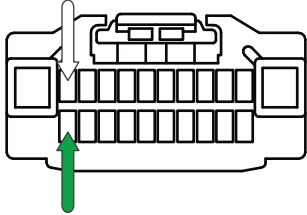
Todos os conectores abaixo são visualizados pelo LADO DOS FIOS.

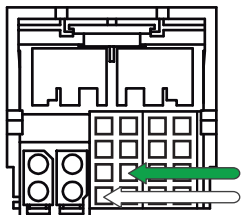
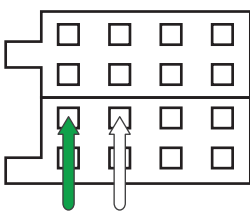
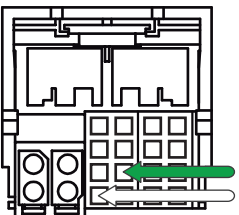
<p>AUDI</p> 	<p>BMW</p> 	<p>CHEVROLET</p>  <p>OBS: Isolar fio BRANCO</p>
<p>CHEVROLET 2</p>  <p>OBS: Isolar fio BRANCO</p>	<p>CHRYSLER/DODGE/JEEP 1</p> 	<p>CHRYSLER/DODGE/JEEP 2</p> 
<p>CITROEN/PEUGEOT</p> 	<p>FIAT 1</p> 	<p>FIAT 2</p> 

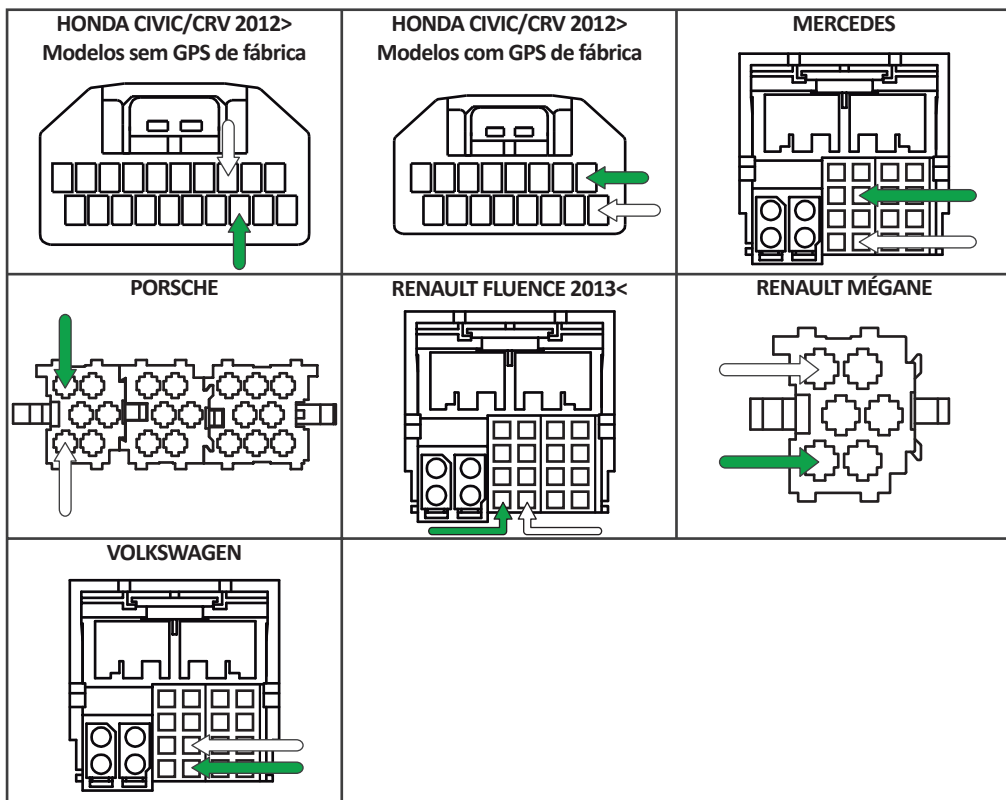

5. COMPUTADOR DE BORDO (PEUGEOT 307, 308, 407 e 408)

Pressione a tecla SOURCE por cinco segundos para controlar o computador de bordo.

Use as teclas:

Volume+: Enter

Volume-: Esc

Seek+: Menu

Scroll: Navegar nas funções do MENU

Para sair do controle do computador de bordo pressione a tecla VOLUME- (função Esc) até sair do MENU do computador de bordo, depois pressione a tecla SOURCE por cinco segundos para retornar a controlar o rádio.